

# INSPIRATIONGUIDE

2026

PENS & WRITING

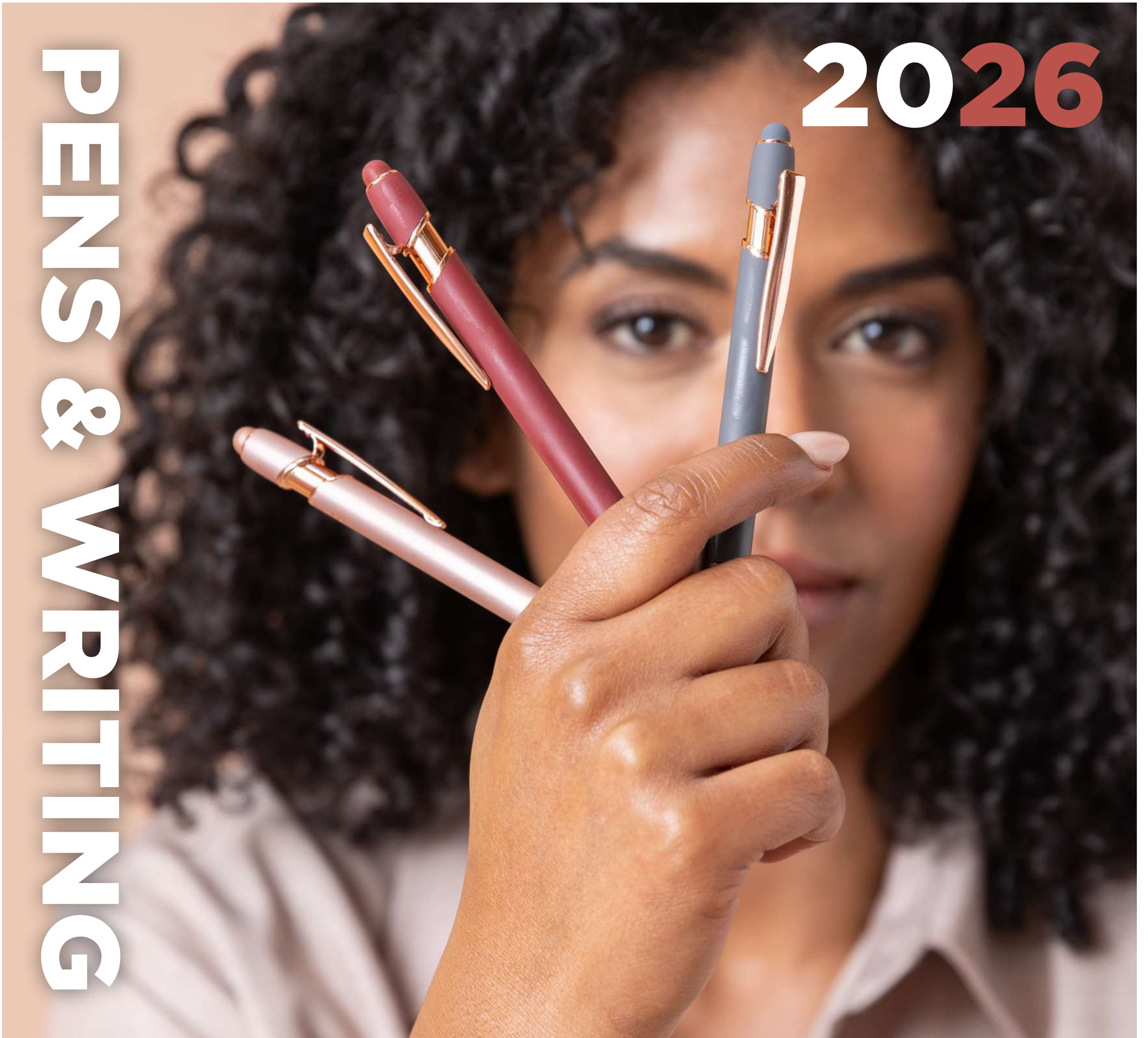

# PENS & WRITING





**BALLPOINT PENS**

**FOUNTAIN PENS**

**ROLLERBALL PENS**

**GIFT SETS**

**COLOURING SETS**



**BRANDS**

# BALLPOINT PENS

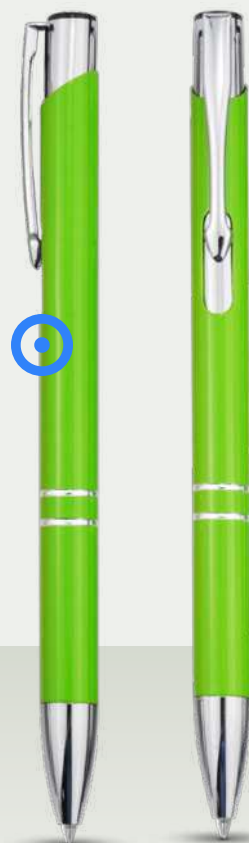

Our collection of ballpoint pens ranges from affordable bestsellers such as Moneta and Nash to premium brands like Parker and Waterman. The pens are made from a variety of materials and finishes, including recycled plastic, aluminium, and bamboo. Our range offers something for every taste and budget.



**107105**  **107440**  | **MONETA ALUMINIUM CLICK BALLPOINT PEN** | Aluminium 100% | Ø 0.8 x 13.5 cm | 0.113 kg CO<sub>2</sub>e  

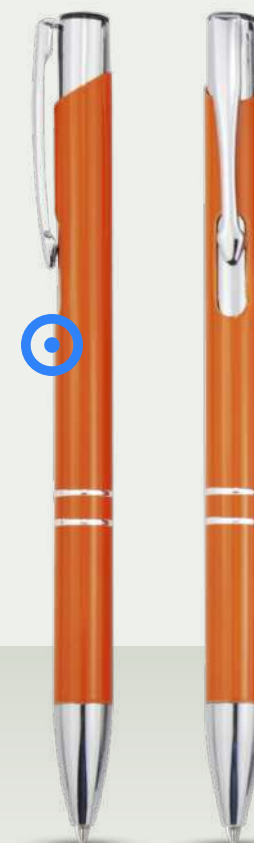



**107822**  **107984**  | **MONETA RECYCLED ALUMINIUM BALLPOINT PEN** | Recycled Aluminium 100% | Ø 1 x 13.6 cm | 0.058 kg CO<sub>2</sub>e  





107163  107583  | **MONETA ANODIZED ALUMINIUM CLICK BALLPOINT PEN** | Aluminium | Ø 0.8 x 13.5 cm | 0.119 kg CO<sub>2</sub>e

●○○●●●

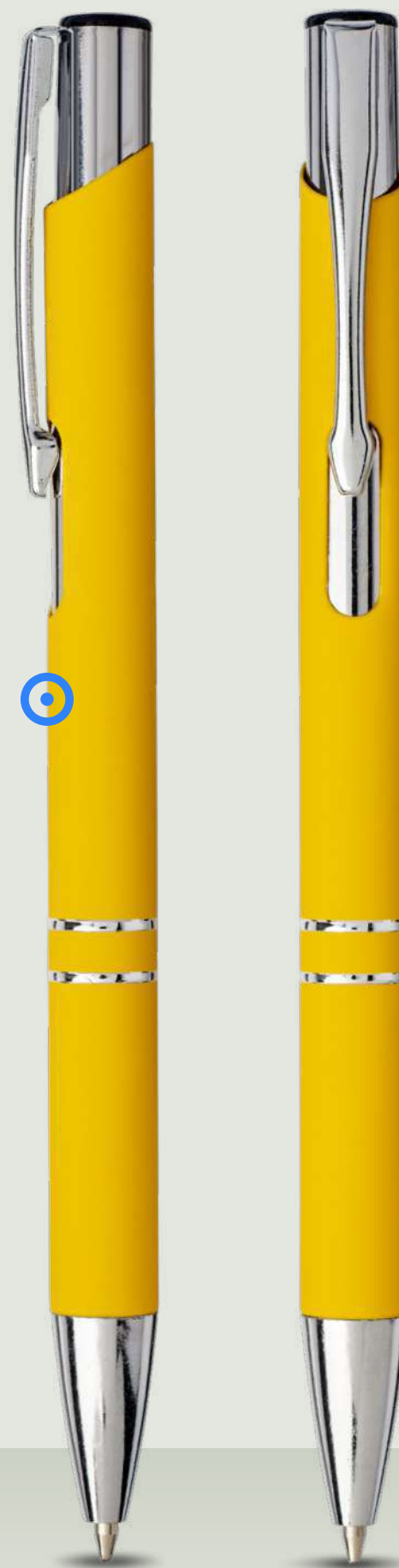

107298  | **MONETA ANODIZED ALUMINIUM CLICK STYLUS BALLPOINT PEN** | Aluminium | Ø 0.8 x 13.8 x 13.5 cm | 0.157 kg CO<sub>2</sub>e

●●



107437  | **MONETA SOFT TOUCH BALLPOINT PEN** | Aluminium | Ø 0.8 x 13.5 cm | 0.153 kg CO<sub>2</sub>e

●○○●●●

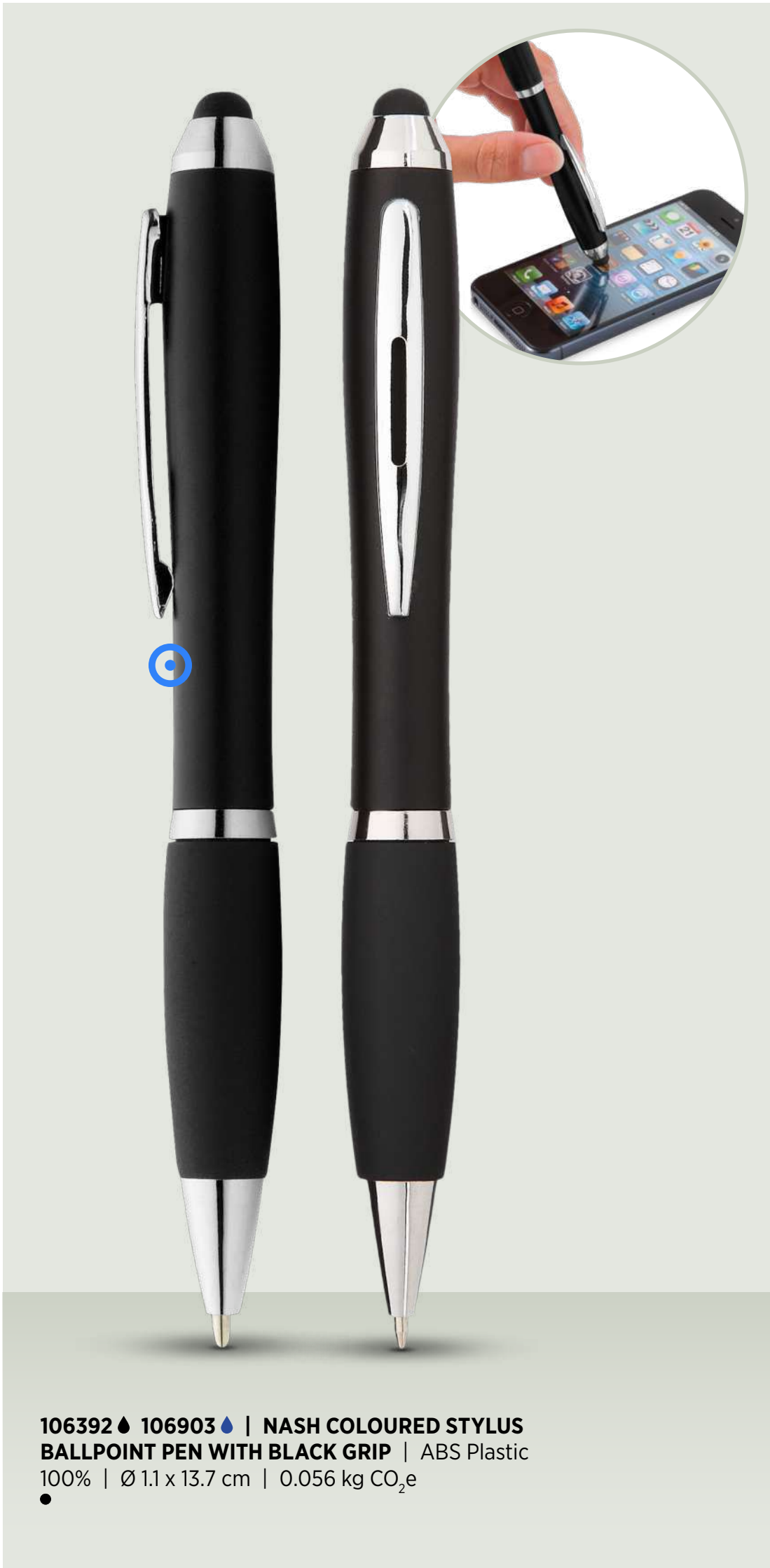

**106392 ♠ 106903 ♠ | NASH COLOURED STYLUS BALLPOINT PEN WITH BLACK GRIP** | ABS Plastic 100% | Ø 1.1 x 13.7 cm | 0.056 kg CO<sub>2</sub>e



**106371 ♠ | NASH BALLPOINT PEN WITH WHITE BARREL AND COLOURED GRIP** | ABS Plastic 100% | Ø 1.3 x 14 cm | 0.061 kg CO<sub>2</sub>e



**106900 ♠ | NASH BALLPOINT PEN WHITE BARREL AND COLOURED GRIP** | ABS Plastic 100% | Ø 1.3 x 14 cm | 0.061 kg CO<sub>2</sub>e



**106399 ♠ 107078 ♠ | NASH BALLPOINT PEN WITH COLOURED BARREL AND GRIP** | ABS Plastic 100% | Ø 1.3 x 14 cm | 0.056 kg CO<sub>2</sub>e

○●●●●●●●●●●●●●●○



**107972 ♠ 107973 ♠ | NASH RECYCLED PLASTIC BALLPOINT PEN** | Recycled ABS Plastic 100% | Ø 1.3 x 13.9 cm | 0.028 kg CO<sub>2</sub>e

●●●●●●●●●●●●●●●●



**106296 ♠ | NASH RECYCLED PLASTIC BALLPOINT PEN WITH BLACK TRIMS** | Recycled ABS Plastic 100% | Ø 1.3 x 13.9 cm | 0.028 kg CO<sub>2</sub>e

●●●●●●●●●●●●●●●●



**107809** ♠ | **MAUNA RECYCLED PET GEL ROLLERBALL PEN** |  
Recycled PET Plastic 100% | Ø 1.2 x 14.3 cm | 0.031 kg CO<sub>2</sub>e  
●○●●

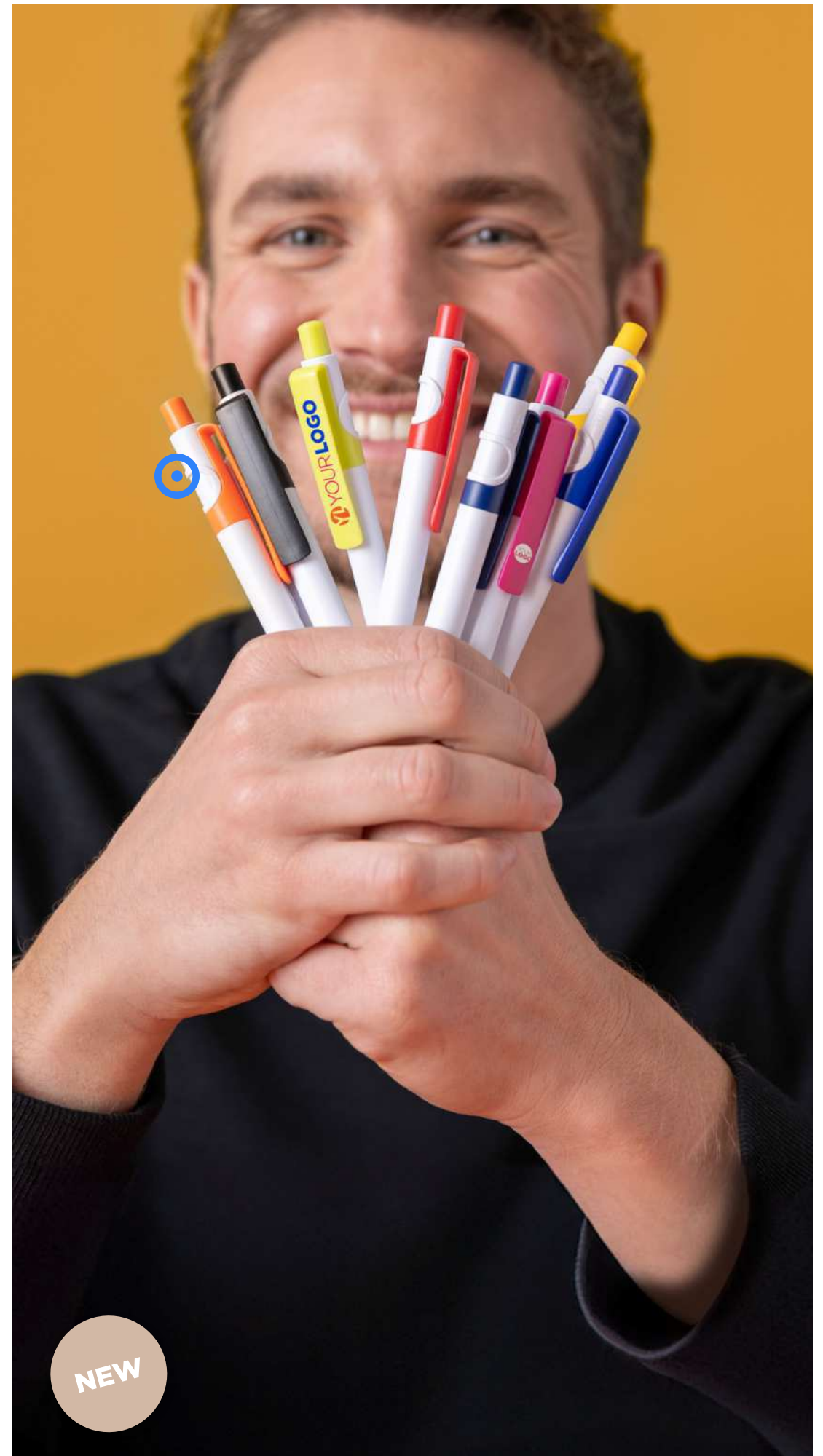

NEW

**107965** ♠ **107966** ♠ | **UNICA RECYCLED PLASTIC BALLPOINT PEN** |  
Recycled ABS Plastic 100% | Ø 1 x 13.8 cm | 0.021 kg CO<sub>2</sub>e  
●○●●●●●●



**106378** ♣ | **FELD RCS RECYCLED BALLPOINT PEN WITH METALLIC FINISH** | Recycled ABS Plastic | Ø 1 x 14.3 cm | 0.027 kg CO<sub>2</sub>e  
 ●○●●●●●

**106297** ♣ **106299** ♣ | **IPE RCS RECYCLED BALLPOINT PEN** | Recycled ABS Plastic 100% | 1 cm | 0.020 kg CO<sub>2</sub>e  
 ●○●●●●●●●

**107385** ♣ | **MIDAR CORK AND WHEAT STRAW BALLPOINT PEN** | Cork 100% | Ø 1 x 14 cm | 0.111 kg CO<sub>2</sub>e  
 ●●●●●



**107921** ♠ **107922** ♠ | **LORENA RABS BALLPOINT PEN** | Recycled ABS  
Plastic | Ø 1.02 x 14.3 cm | 0.025 kg CO<sub>2</sub>e

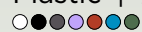

**107898** ♠ **107899** ♠ | **DELFINA PHONE HOLDER PEN** | FSC certified  
bamboo | Ø 1 x 14.7 cm | 0.016 kg CO<sub>2</sub>e



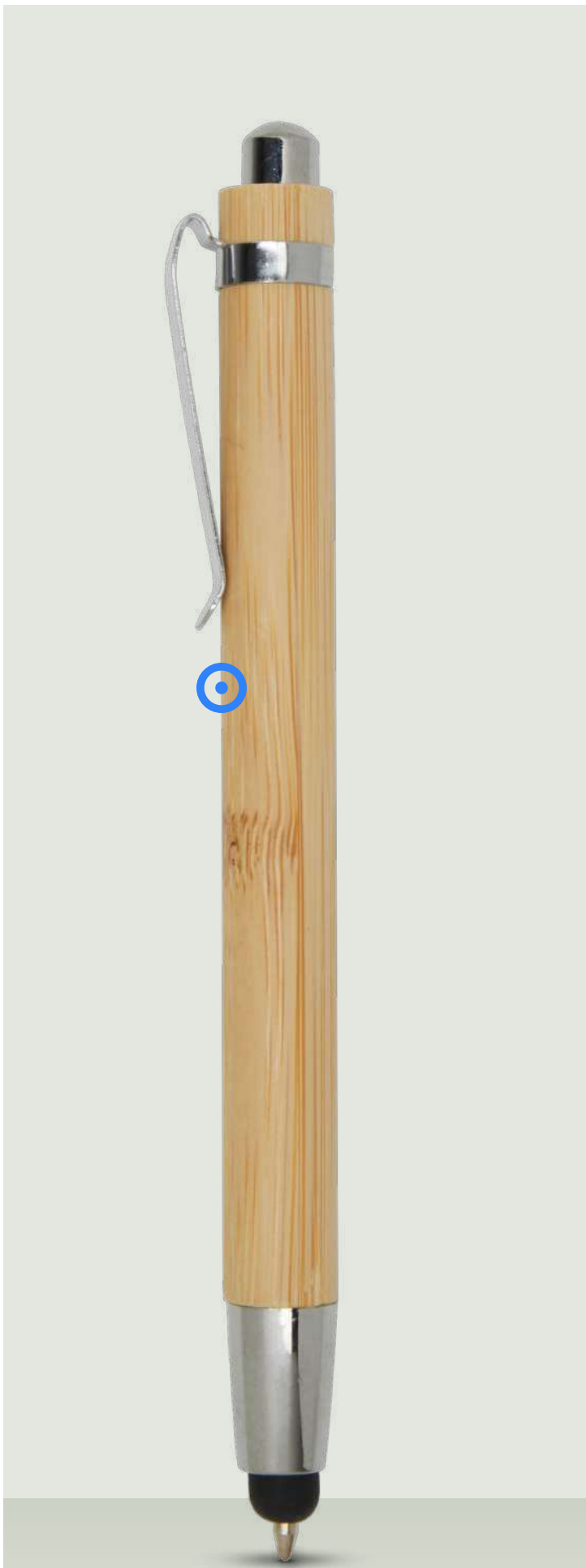

**106255** ◆ | **ELM BAMBOO BALLPOINT PEN** |  
 FSC certified bamboo 100% | Ø 1.3 x 13.9 cm |  
 0.016 kg CO<sub>2</sub>e



**107892** ◆ | **SAMAMBU BAMBOO DUO PEN** |  
 FSC certified bamboo | Ø 0.9 x 17.2 cm |  
 0.012 kg CO<sub>2</sub>e

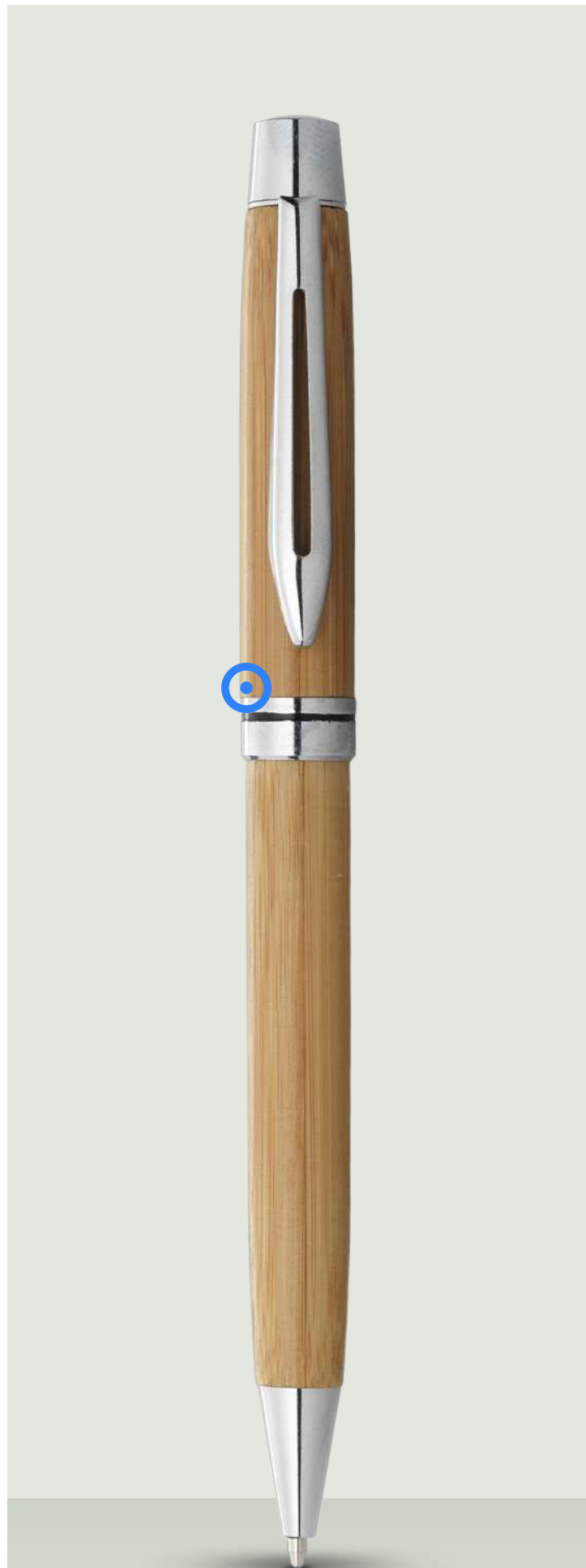

**106282** ◆ | **JAKARTA BAMBOO BALLPOINT PEN** |  
 Bamboo 100% | Ø 1.2 x 13.8 cm |  
 0.045 kg CO<sub>2</sub>e







107876  107877  | DARIUS RECYCLED ALUMINIUM BALLPOINT PEN | Recycled Aluminium | Ø 1.02 x 13.8 cm | 0.052 kg CO<sub>2</sub>e

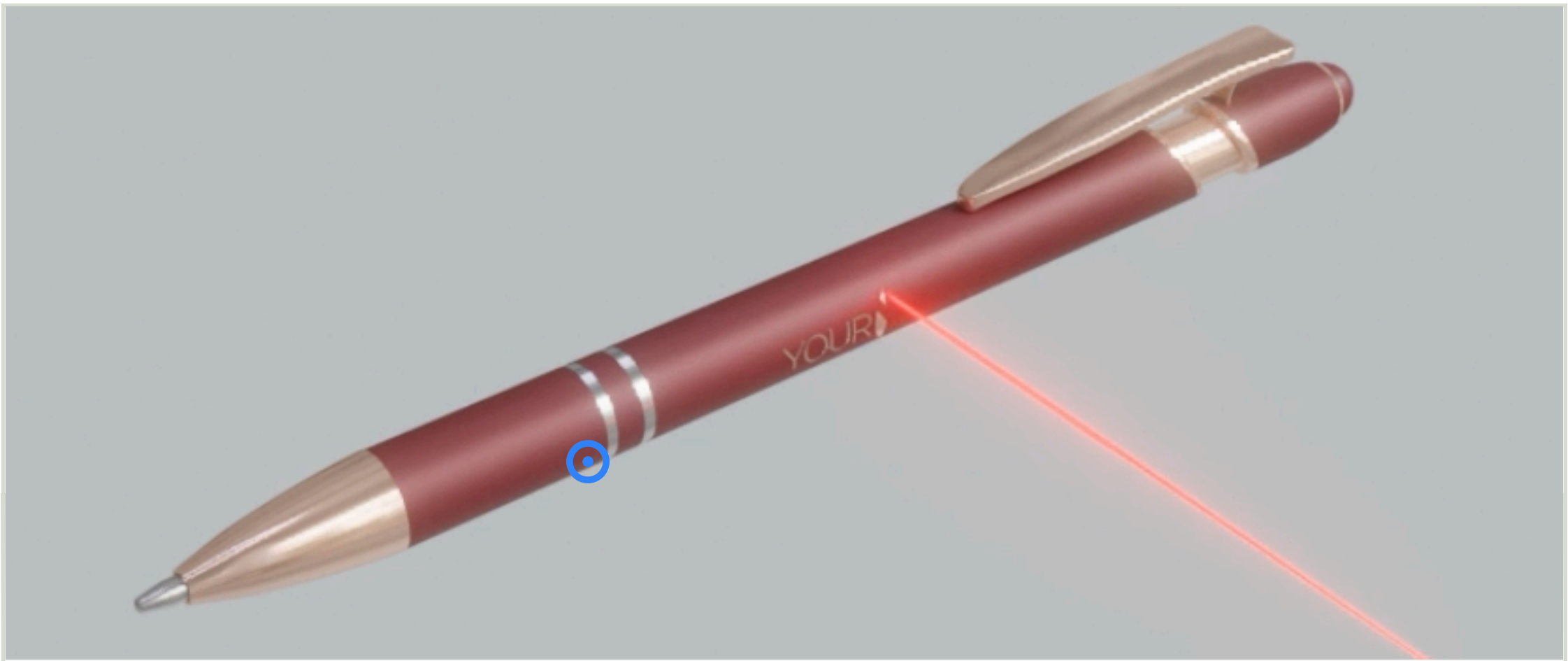

106246  107974  | NANNA BALLPOINT PEN WITH ROSE GOLD FINISH | Recycled Aluminium 100% | Ø 1 x 14.4 cm | 0.080 kg CO<sub>2</sub>e





106129 ♠ 107971 ♠ | ZIGUUR RECYCLED ALUMINIUM BALLPOINT  
PEN | Recycled Aluminium 100% | Ø 1.1 x 14 cm | 0.080 kg CO<sub>2</sub>e  
●●●●●○

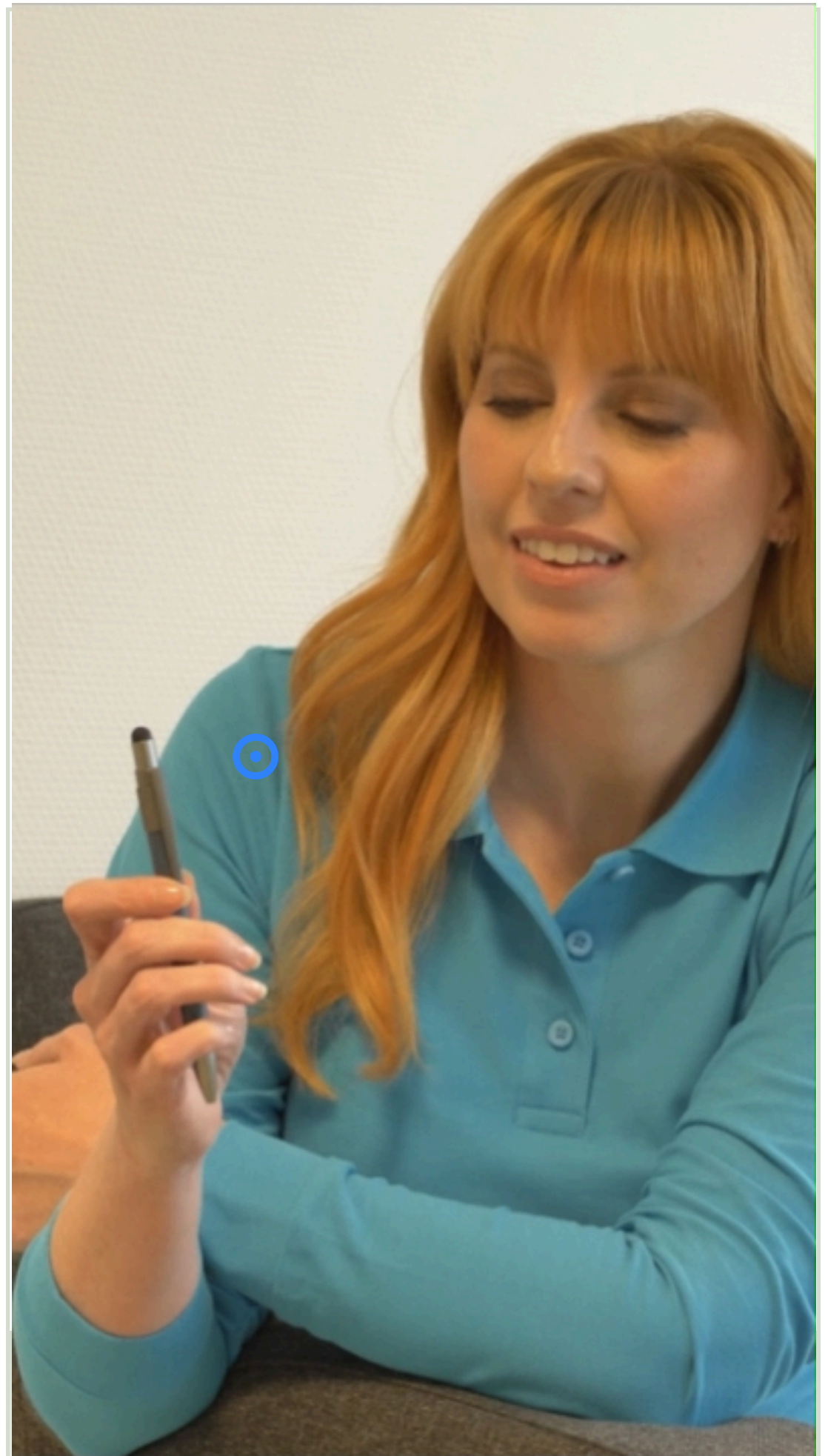

106447 ♠ | RILL RCS RECYCLED BALLPOINT PEN WITH STYLUS  
AND FIDGET SPINNER | Recycled Aluminium | Ø 1.05 x 14.7 cm |  
0.076 kg CO<sub>2</sub>e  
○●●●●○



MARKS  AN

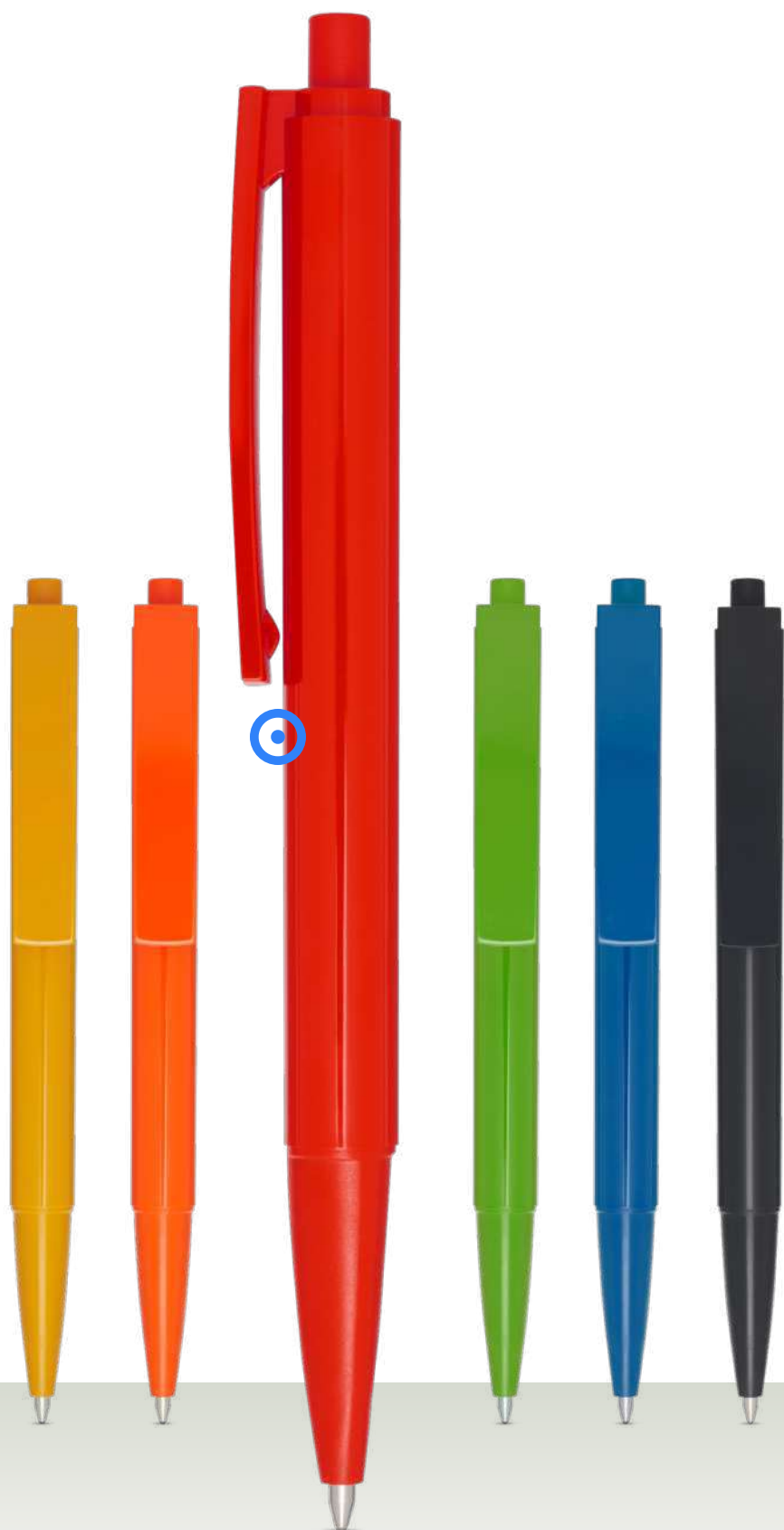

107909  107910  | ELSA RECYCLED PLASTIC BALLPOINT PEN |  
Recycled ABS Plastic 100% | Ø 1.1 x 13.9 cm | 0.023 kg CO<sub>2</sub>e  

MARKS  AN

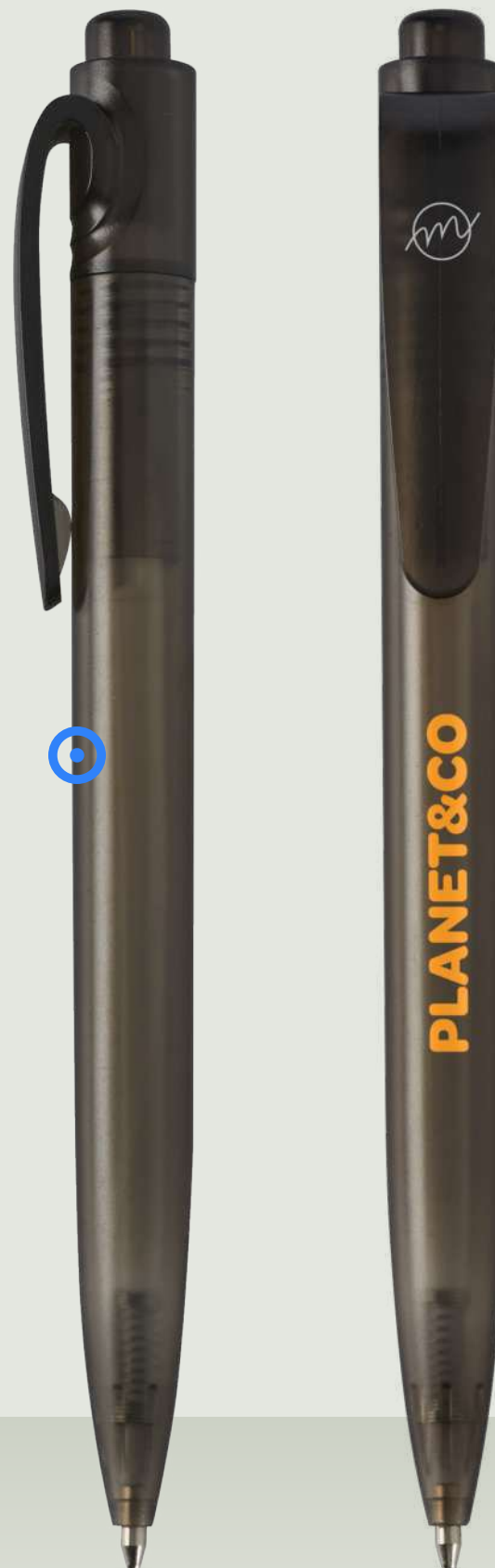

107835  107861  | THALAASA OCEAN-BOUND PLASTIC  
BALLPOINT PEN | Recycled Plastic | Ø 1.1 x 14.3 cm | 0.019 kg CO<sub>2</sub>e  

MARKS  AN



107926  107927  | **LUCIA RECYCLED PLASTIC BALLPOINT PEN** | Recycled Plastic 100% | Ø 1.3 x 14.5 cm | 0.016 kg CO<sub>2</sub>e  

MARKS  AN





107928  107929  | **MARTHA RECYCLED PLASTIC BALLPOINT PEN** | Recycled Plastic 100% | Ø 1.05 x 14.8 cm | 0.019 kg CO<sub>2</sub>e  



MARKS  AN



**107930**  | **ANA RECYCLED PLASTIC BALLPOINT PEN** | Recycled Plastic 100% | Ø 1 x 14.2 cm | 0.032 kg CO<sub>2</sub>e  

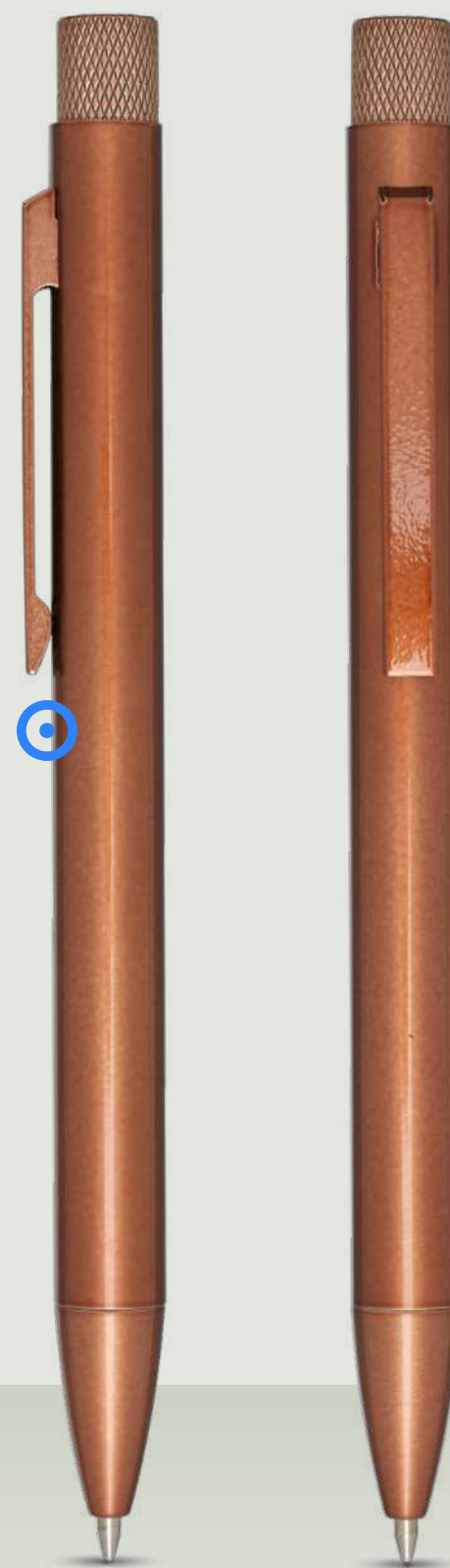

**107918**  **107919**  | **BEATRIZ RECYCLED BRASS BALLPOINT PEN** | Recycled brass | Ø 1 x 14 cm | 0.020 kg CO<sub>2</sub>e  

# PARKER JOTTER IS NOW MADE FROM 55%\* RECYCLED MATERIALS

\*55% calculated on weight of each component.  
Excludes refill.

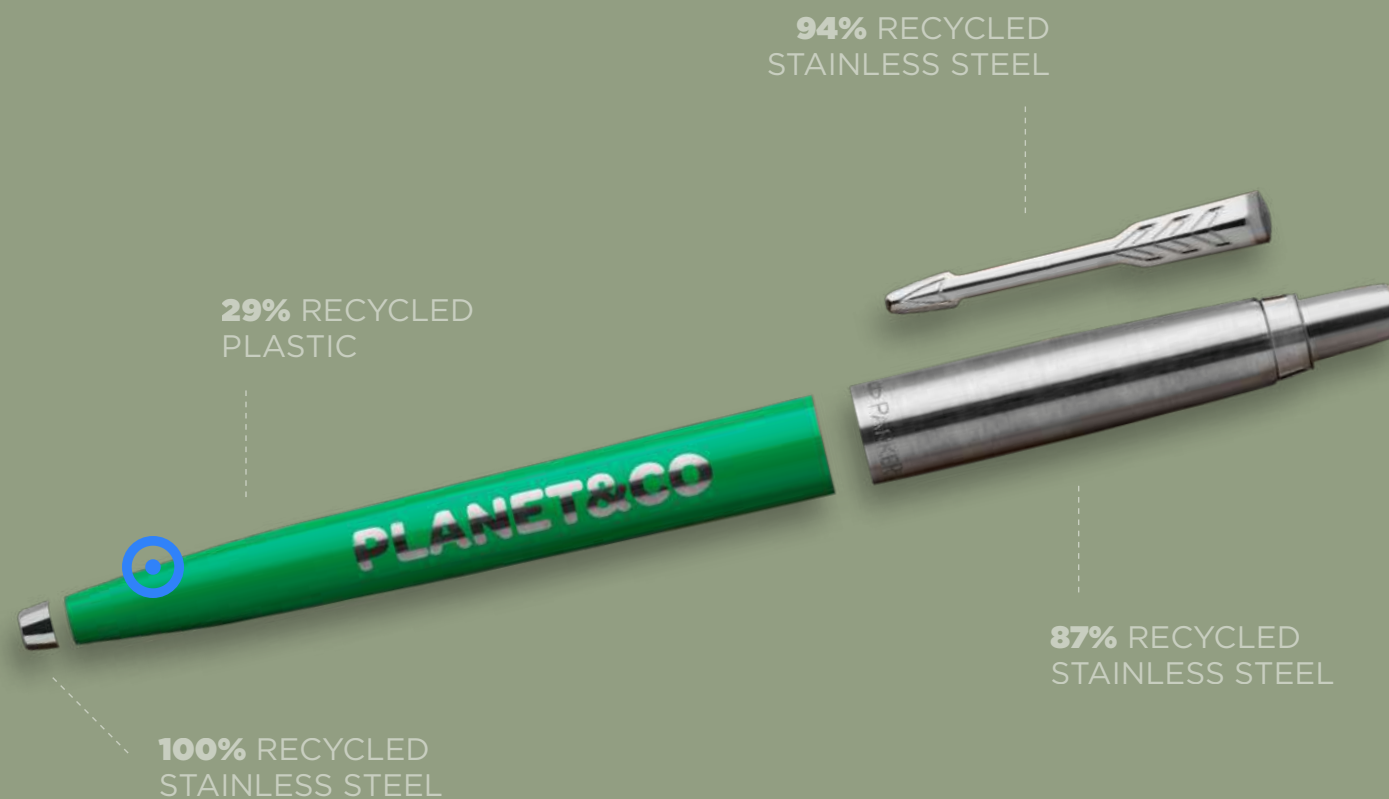

107823  107865  | PARKER JOTTER RECYCLED BALLPOINT PEN | Recycled Plastic 100% | Ø 0.85 x 12.9 cm | 0.029 kg CO<sub>2</sub>e



PEN RECYCLED CONTENT

106476 ♠ 106478 ♠ | PARKER JOTTER BALLPOINT PEN |  
Stainless Steel 100% | Ø 0.97 x 12.9 cm | 0.127 kg CO<sub>2</sub>e



107758 ♠ | PARKER IM BALLPOINT PEN |  
Brass 100% | Ø 1.1 x 13.6 cm | 0.173 kg CO<sub>2</sub>e



MADE IN EUROPE



107801 | PARKER IM ACHROMATIC BALLPOINT PEN |  
Stainless Steel 100% | Ø 1.1 x 13.5 cm | 0.216 kg CO<sub>2</sub>e



107021 | PARKER IM BALLPOINT PEN |  
Brass 100% | Ø 1.1 x 13.6 cm | 0.171 kg CO<sub>2</sub>e





**WATERMAN**  
PARIS

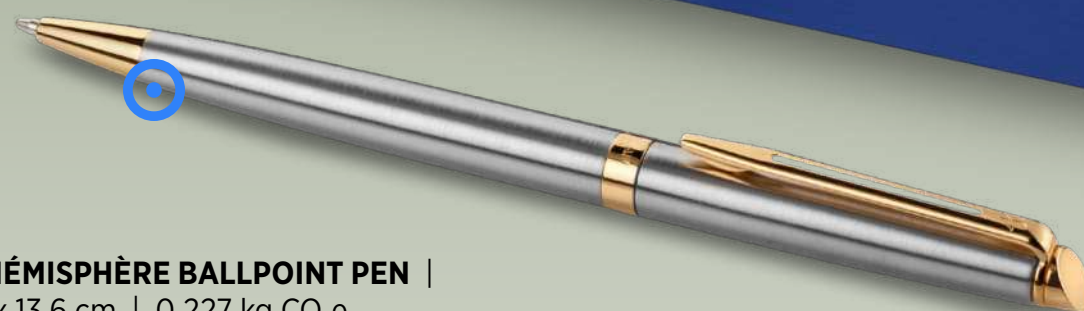

**106516** | WATERMAN HÉMISPHERE BALLPOINT PEN |  
Stainless Steel 100% | Ø 1 x 13.6 cm | 0.227 kg CO<sub>2</sub>e  
●○

  
**MADE IN  
EUROPE**

**WATERMAN**  
PARIS



**NEW**

**106367** | WATERMAN HEMISPHERE BALLPOINT PEN M |  
Stainless Steel 100% | 13.9 x 0.9 x 1.2 cm | 0.302 kg CO<sub>2</sub>e  
●●●

# FOUNTAIN PENS

**LUXE**



**107832** | LUCETTA RECYCLED ALUMINIUM FOUNTAIN PEN |  
Recycled Aluminium 100% | Ø 1.4 x 13.8 cm | 0.123 kg CO<sub>2</sub>e

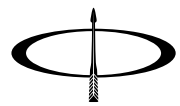

PARKER



**107420** | PARKER JOTTER STAINLESS STEEL FOUNTAIN PEN |  
Stainless Steel 100% | Ø 1 x 12.1 cm | 0.126 kg CO<sub>2</sub>e

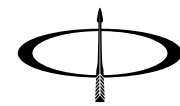

PARKER



**107760** | PARKER IM FOUNTAIN PEN | Brass 100% |  
Ø 1.3 x 13.8 cm | 0.171 kg CO<sub>2</sub>e



**WATERMAN**  
PARIS

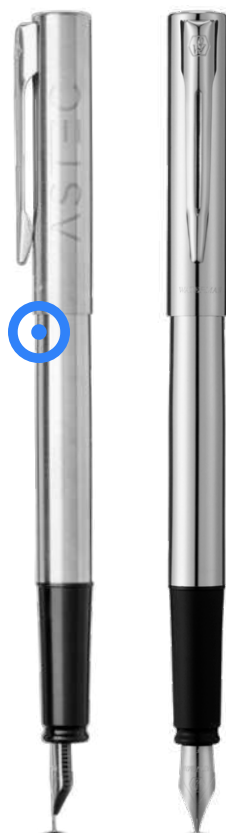

**106508** | WATERMAN GRADUATE FOUNTAIN PEN | Metal 100% |  
Ø 1.1 x 13.6 cm | 0.181 kg CO<sub>2</sub>e

**WATERMAN**  
PARIS



**106507** | WATERMAN EXPERT FOUNTAIN PEN | Brass 100% |  
Ø 1.3 x 17.5 cm | 0.215 kg CO<sub>2</sub>e

**WATERMAN**  
PARIS

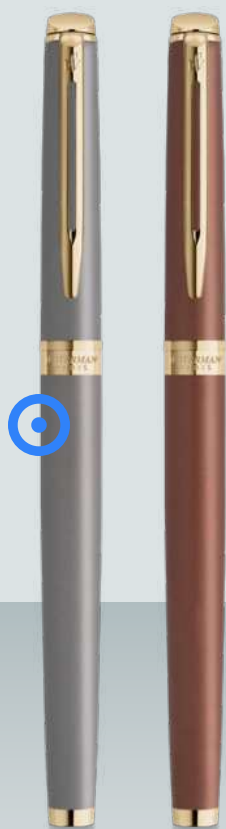

**106374** | WATERMAN HEMISPHERE FOUNTAIN PEN M |  
Stainless Steel | 13.6 x 1.2 x 1.5 cm | 0.254 kg CO<sub>2</sub>e



# ROLLERBALL PENS

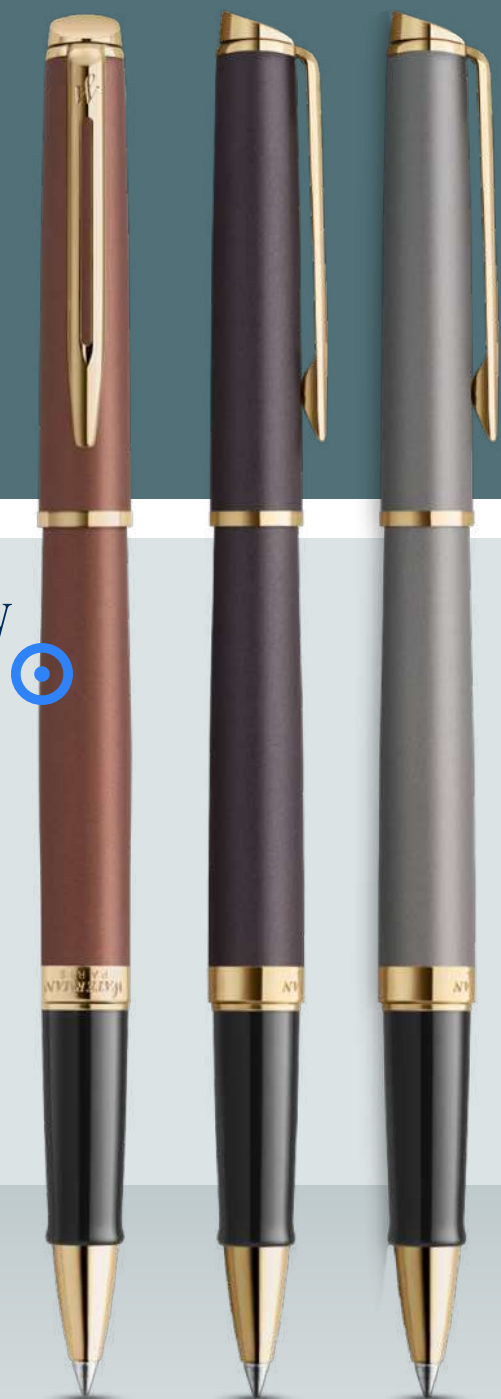

**WATERMAN**  
PARIS



**106372 | WATERMAN HEMISPHERE ROLLERBALL PEN F** | Stainless Steel 100% | 13.6 x 1.2 x 1.5 cm | 0.254 kg CO<sub>2</sub>e  
●●●

**LUXE**



**107292** ● | **DORÉ ROLLERBALL PEN** | Metal | Ø 1.1 x 14 cm | 0.287 kg CO<sub>2</sub>e  
●

**WATERMAN**  
PARIS



**106510** ● | **WATERMAN GRADUATE ROLLERBALL PEN** | Metal 100% | Ø 1.1 x 13.6 cm | 0.215 kg CO<sub>2</sub>e  
○

**WATERMAN**  
PARIS



**106515** ● | **WATERMAN HÉMISPHERE ROLLERBALL PEN** | Stainless Steel 100% | Ø 1.05 x 17.6 cm | 0.225 kg CO<sub>2</sub>e  
○





**106484** | PARKER VECTOR ROLLERBALL PEN | Stainless Steel  
100% | Ø 1 x 12.9 cm | 0.145 kg CO<sub>2</sub>e



**107023** | PARKER IM ROLLERBALL PEN | Brass 100% |  
Ø 1.3 x 13.8 cm | 0.171 kg CO<sub>2</sub>e

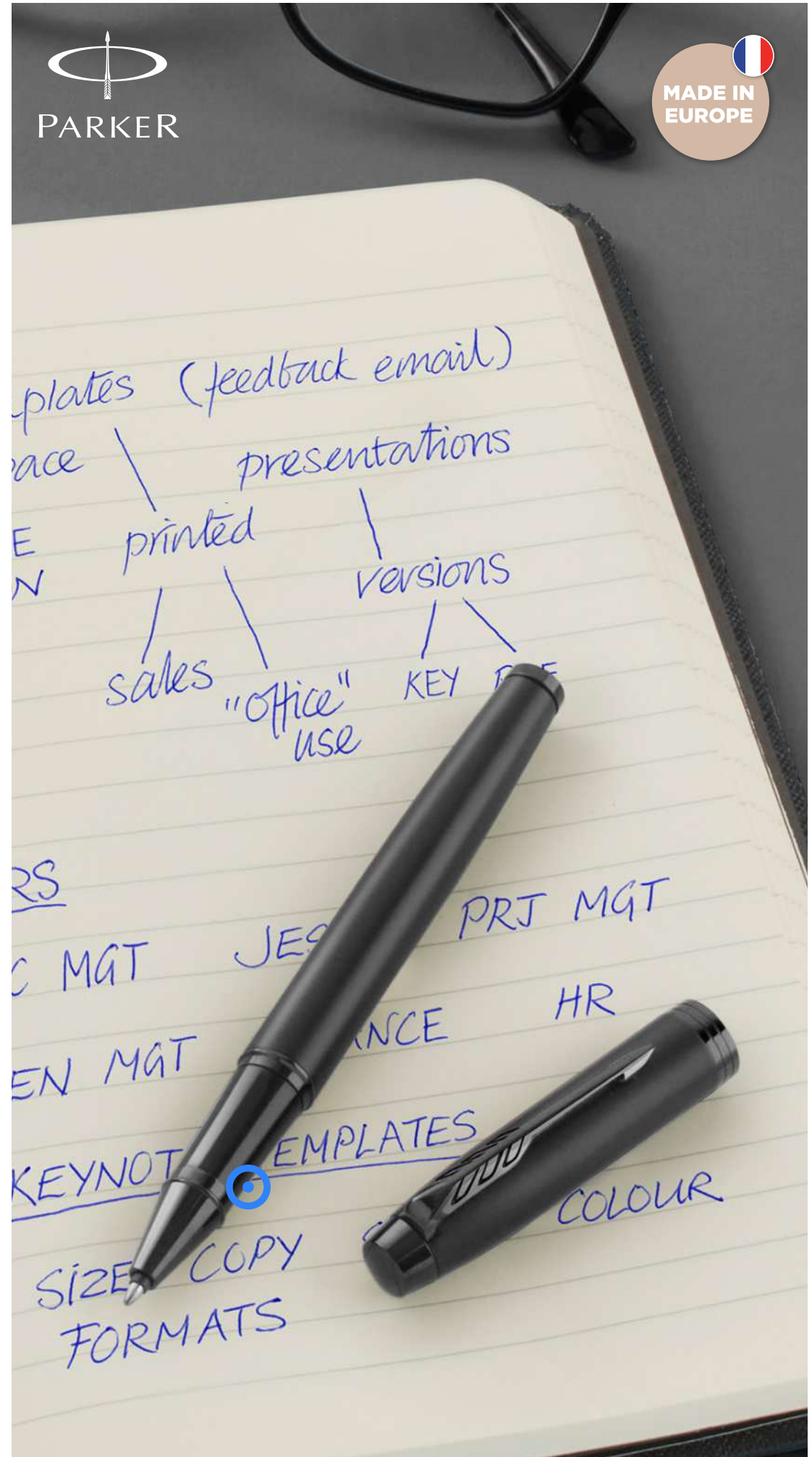

**107802** | PARKER IM ACHROMATIC ROLLERBALL PEN | Stainless Steel 100% | Ø 1.1 x 11.6 cm | 0.215 kg CO<sub>2</sub>e

# GIFT SETS



Our gift sets offer more than a pen – they deliver a complete and memorable gift experience. Sets include elegant combinations like ballpoint and rollerball pens or a notebook and pen in a stylish box. With printing options, such as embossing or laser engraving, they make a thoughtful gift for every recipient.

**LUXE**



**107838 ♠ | LUCETTO RECYCLED ALUMINIUM BALLPOINT AND ROLLERBALL PEN GIFT SET** | Recycled Aluminium | Ø 10 x 14 cm | 0.091 kg CO<sub>2</sub>e  
●●●

**LUXE**



**107836 ♠ | DIDIMIS RECYCLED STAINLESS STEEL BALLPOINT AND ROLLERBALL PEN SET** | Recycled stainless steel | Ø 0.1 x 13.2 cm | 0.143 kg CO<sub>2</sub>e  
●

**LUXE**



**107924 ♠ | LEGATO BALLPOINT AND ROLLERBALL PEN SET** | Recycled brass | Ø 1.2 x 14.1 cm | 0.045 kg CO<sub>2</sub>e  
●



LUXE



**107925** | LEGATO A5 NOTEBOOK AND ROLLERBALL PEN SET | FSC certified paper | 24.5 x 23.3 x 2 cm | 0.388 kg CO<sub>2</sub>e

LUXE



**106258** | LEGATO ELEGANCE A5 HARD COVER NOTEBOOK AND ROLLERBALL PEN SET | FSC certified paper 100% | 19.2 x 22.5 cm | 0.574 kg CO<sub>2</sub>e

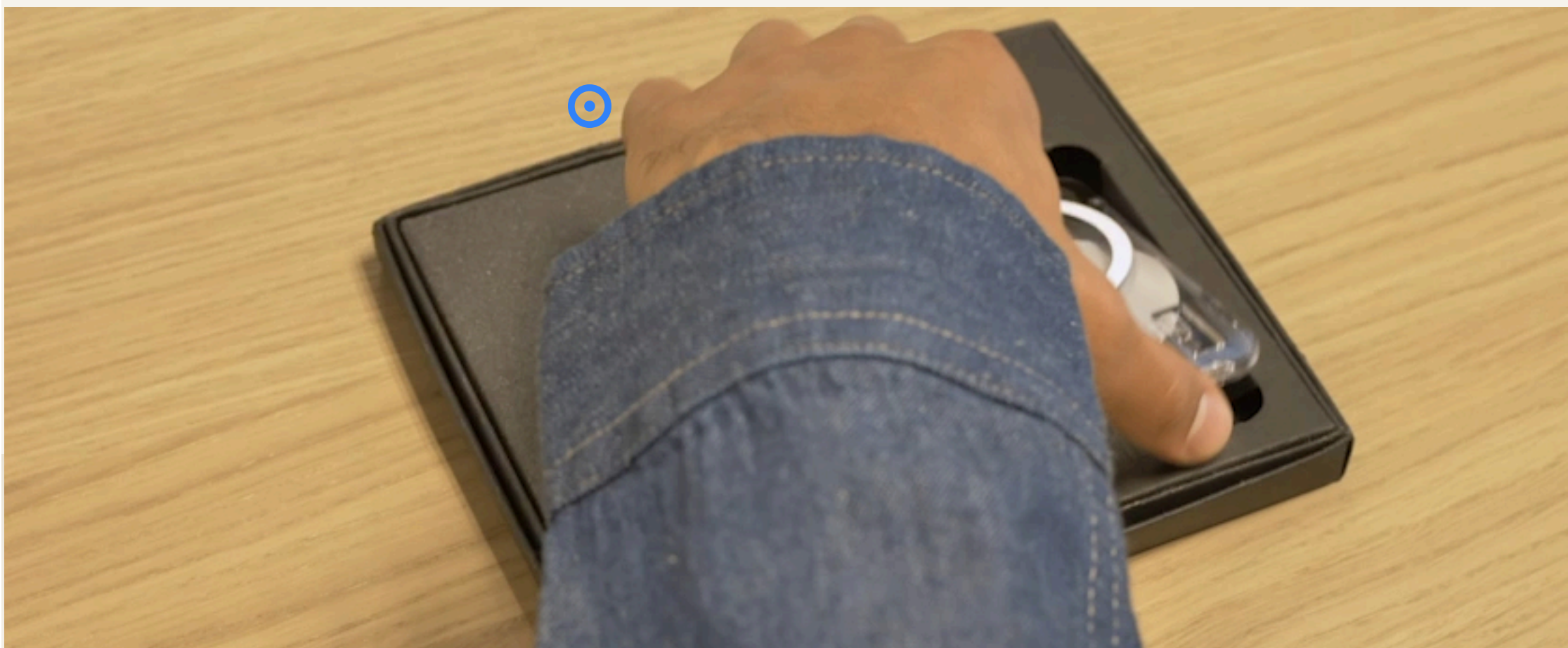

**107164** | KERN A6 HARD COVER NOTEBOOK AND MAGSAFE WALLET GIFT SET | FSC® paper | 18 x 14.8 cm | 0.395 kg CO<sub>2</sub>e

# LUXE



107291 ♣ | LOURE WOOD BARREL BALLPOINT PEN | Metal 100% |  
Ø 1.2 x 14.1 cm | 0.196 kg CO<sub>2</sub>e



107911 ♣ | LAURA A5 HARD COVER NOTEBOOK AND BALLPOINT  
PEN GIFT SET | FSC certified paper | 32 x 27 x 10.3 cm | 2.353 kg CO<sub>2</sub>e



106337 ♣ | MINKA RCS RECYCLED ALUMINIUM BALLPOINT PEN,  
KEYCHAIN AND RFID CARD HOLDER GIFT SET | FSC certified  
bamboo | 16 x 16 x 2.7 cm | 0.455 kg CO<sub>2</sub>e



**107912** ♠ | **CARMEN A5 HARD COVER NOTEBOOK AND BALLPOINT PEN GIFT SET** | FSC certified paper 100% | 36 x 30 x 8 cm | 3.177 kg CO<sub>2</sub>e



LUXE



**107111** ♠ | **TACTICAL NOTEBOOK GIFT SET** | Thermo PU Plastic | 23.5 x 18.2 x 3.2 cm | 2.925 kg CO<sub>2</sub>e

**WATERMAN**  
PARIS

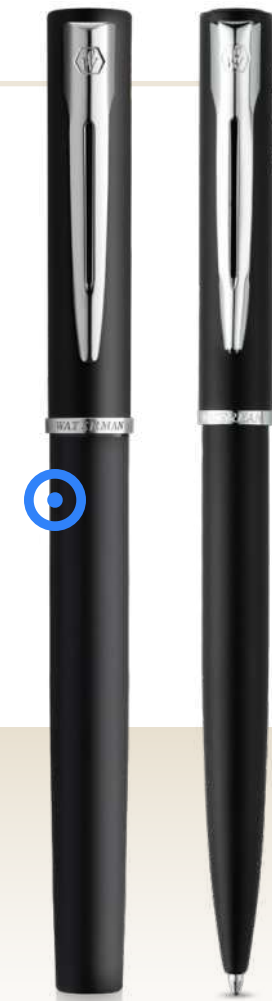

107752 ♦ | **WATERMAN ALLURE BALLPOINT AND ROLLERBALL PEN SET** | Metal 100% | Ø 1.4 x 13.9 cm | 0.487 kg CO<sub>2</sub>e

**WATERMAN**  
PARIS



107824 ♦ | **WATERMAN ALLURE ROLLERBALL AND BALLPOINT PEN SET** | Metal 100% | 20 x 11.2 x 3.9 cm | 0.569 kg CO<sub>2</sub>e



107820 ♠/♠ | PARKER IM ACHROMATIC BALLPOINT AND ROLLERBALL PEN SET WITH GIFT BOX |  
Stainless Steel 100% | 20 x 13.2 x 1.9 cm | 0.432 kg CO<sub>2</sub>e



107342 ♠ | MOLESKINE NOTEBOOK AND PEN GIFT SET |  
Cardboard 100% | 22 x 19 x 2.4 cm | 0.562 kg CO<sub>2</sub>e

# COLOURING SETS



**107066 | TULLIK 4-PIECE COLOURED PENCIL SET** | Paper 100% |  
3.2 x 9 cm | 0.021 kg CO<sub>2</sub>e

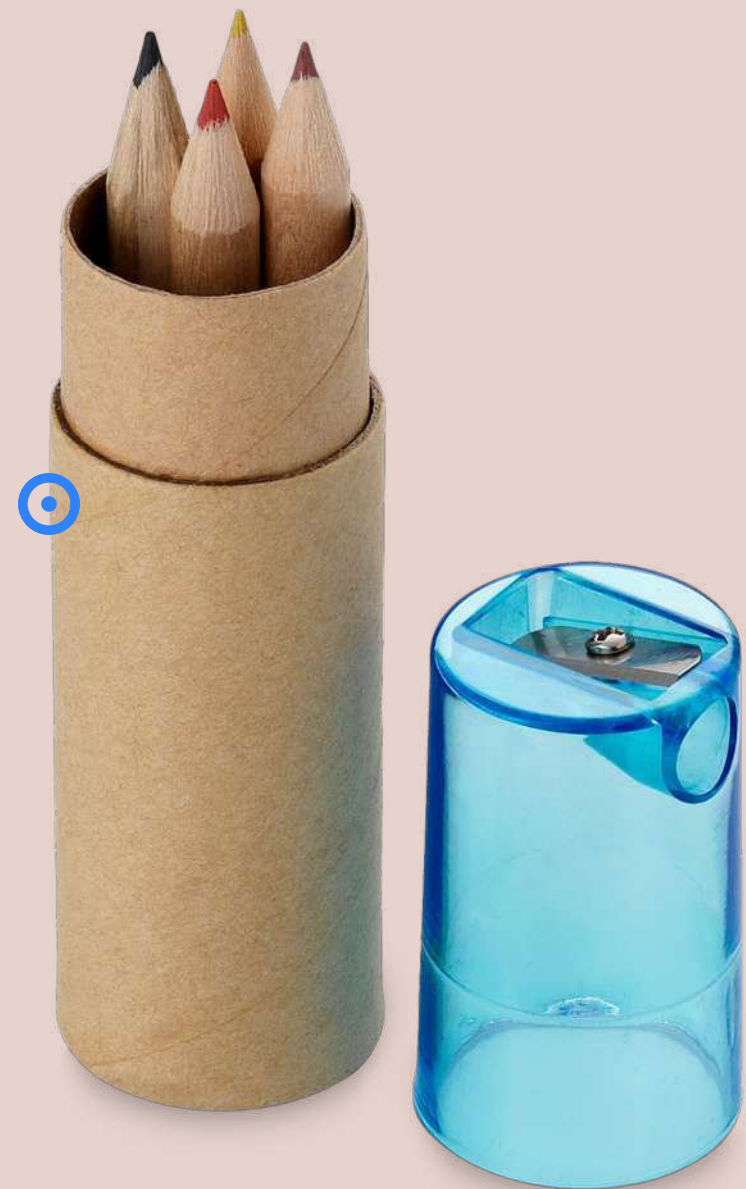

**106220 | KRAM 6-PIECE COLOURED PENCIL SET** | Paper 100% |  
Ø 2.5 x 10.4 cm | 0.053 kg CO<sub>2</sub>e



**106171 | AYO 6-PIECE COLOURED CRAYON SET** | Cardboard 100% |  
5 x 9.5 x 1 cm | 0.050 kg CO<sub>2</sub>e

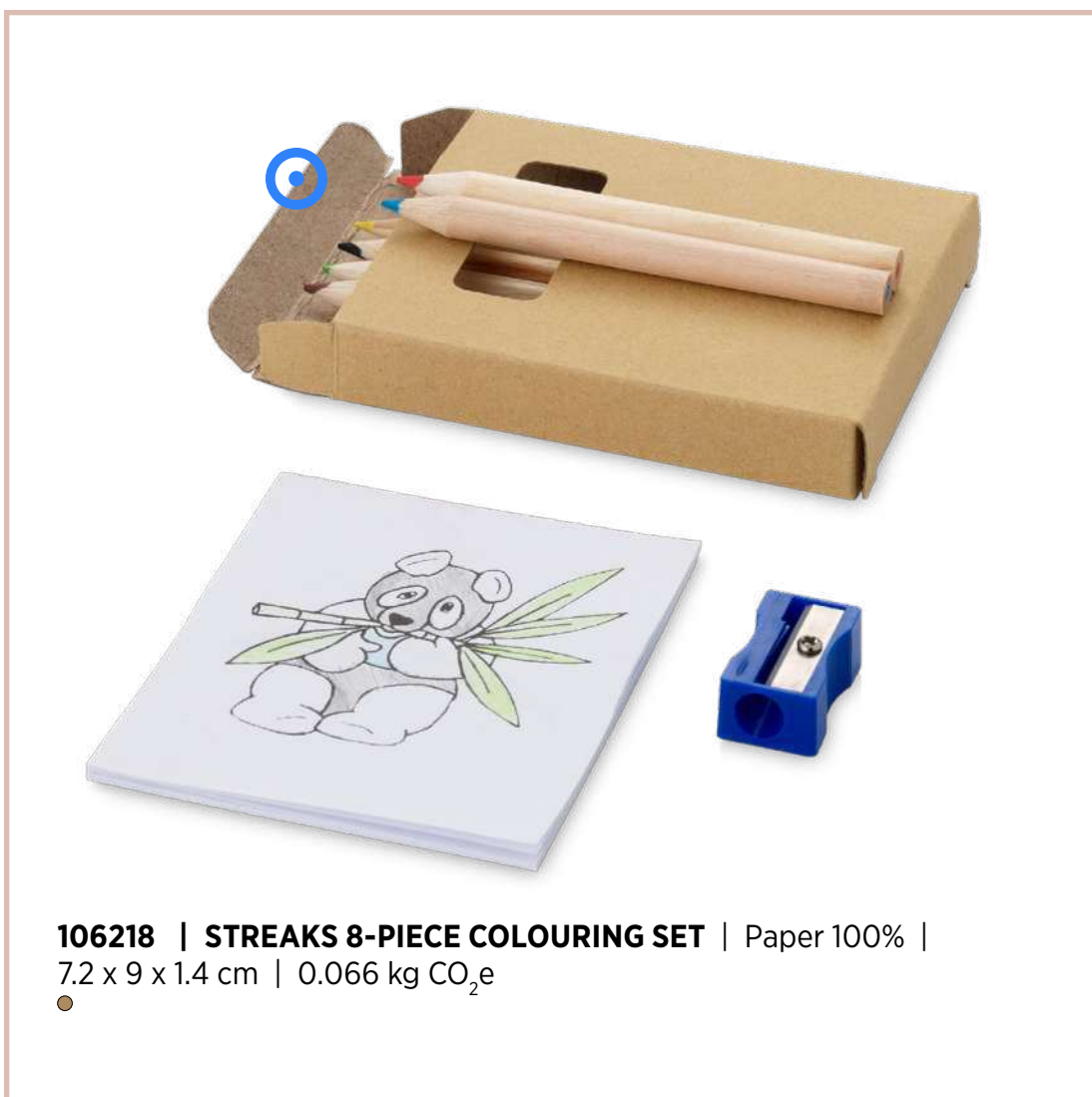

**106218 | STREAKS 8-PIECE COLOURING SET** | Paper 100% |  
7.2 x 9 x 1.4 cm | 0.066 kg CO<sub>2</sub>e



**106219 | AYOLA 6-PIECE COLOURED PENCIL SET** | Paper 100% |  
4.5 x 9 x 0.8 cm | 0.033 kg CO<sub>2</sub>e



**107831 | ARTEMAA 12-PIECE PENCIL COLOURING SET** | Wood 100% | 8.7 x 0.7 cm | 0.055 kg CO<sub>2</sub>e



**106788 | LUCKY 19-PIECE COLOURED PENCIL AND CRAYON SET** | Cardboard 100% | 17.8 x 7.3 x 0.9 cm | 0.103 kg CO<sub>2</sub>e



**544405 | WOODBY 26-PIECE COLOURED PENCIL SET** | Paper 100%, FSC certified paper | Ø 6.5 x 10.5 cm | 0.215 kg CO<sub>2</sub>e



**106167 | PINES 12-PIECE WOODEN PENCIL SET** | Wood 100% | 21.5 x 4 x 3.5 cm | 0.211 kg CO<sub>2</sub>e



**106021 | BOSSY 12-PIECE COLOURED PENCIL SET** | Poplar wood 100% | Ø 3.6 x 14.2 cm | 0.136 kg CO<sub>2</sub>e

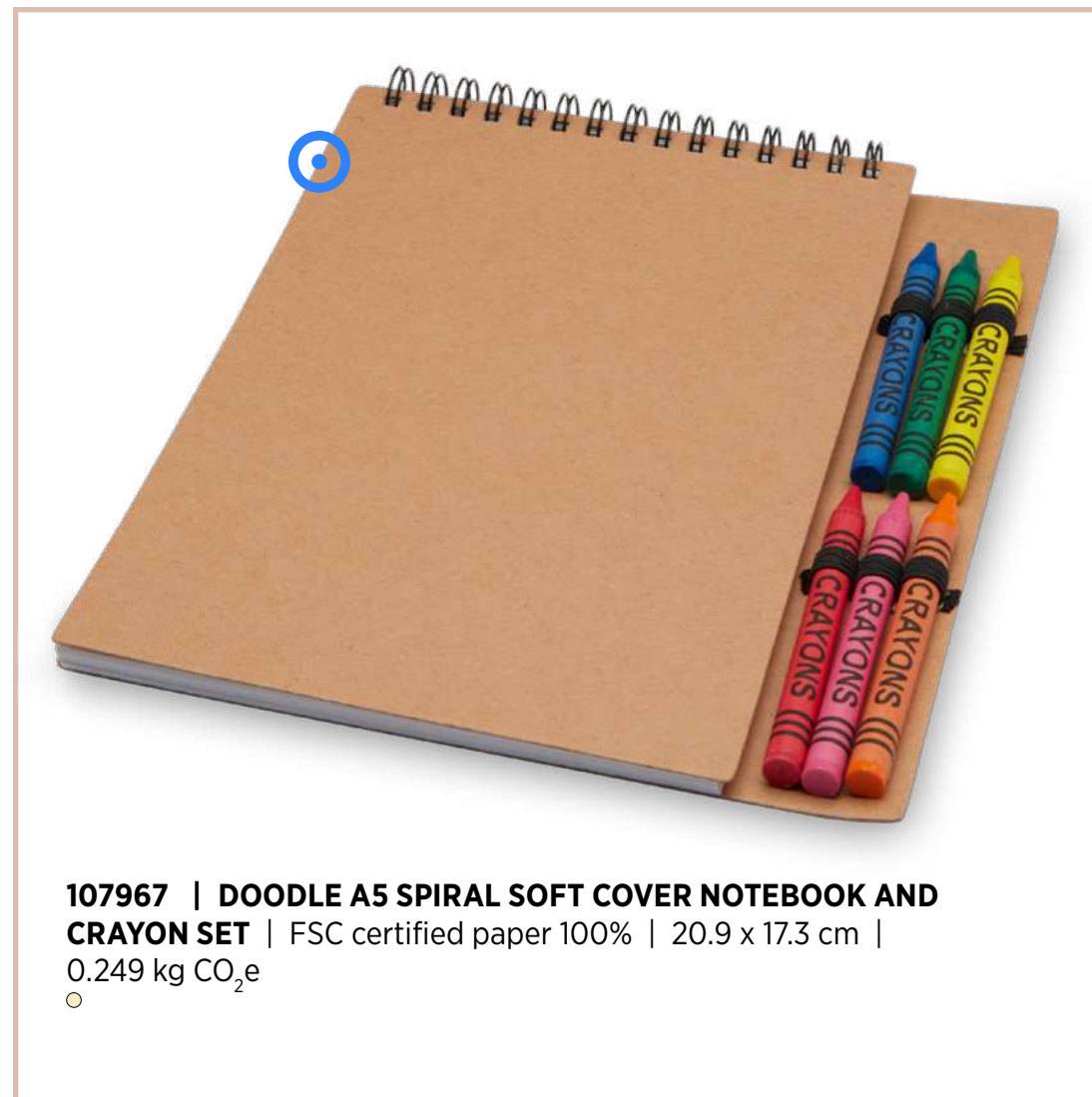

**107967 | DOODLE A5 SPIRAL SOFT COVER NOTEBOOK AND CRAYON SET** | FSC certified paper 100% | 20.9 x 17.3 cm | 0.249 kg CO<sub>2</sub>e



**106254 | FIR COLOURING SET** | FSC certified paper 100% | 21 x 20 cm | 0.226 kg CO<sub>2</sub>e

IC  
GN

**For 135 years Parker has continuously built upon a legacy of craftsmanship and quality, making the Parker name synonymous with excellence in Fine Writing.**

Parker has always believed that all great things take time. This ethos began in 1888 with the dream of a 25-year-old entrepreneur, the brand's founder, George Safford Parker, who stated, 'it will always be possible to make a better pen'. This philosophy is well embodied with the Parker Jotter pen. After nine years spent perfecting the research and technology, the iconic Jotter was launched in January 1954. The Parker Jotter has become one of the world's most iconic pens and is still to this day renowned for its style, reliability and functionality, down to its signature click. It has been the everyday writing instrument of choice for generations and remains relevant to the modern consumer 65 years on.



# WATERMAN

PARIS



# SHOWCASE YOUR STYLE AND SOPHISTICATION

Waterman gives people the confidence to showcase their style and sophistication. Crafted in France, Waterman pens embody a Parisian style and grace that has defined elegance since 1883. Made with precious materials and with beautiful designs, Waterman is dedicated to making its pens the perfect balance of beauty and innovation, empowering those writing with a Waterman to leave their mark of French sophistication.

The brand was founded by Lewis Edson Waterman in New York and in 1900, Waterman first gained notoriety at the Exposition Universelle in Paris. There the brand was awarded a Gold Medal of Excellence, the highest accolade available.



# GIFT SETS



GOOD



BETTER



BEST

# BALLPOINT PENS



GOOD

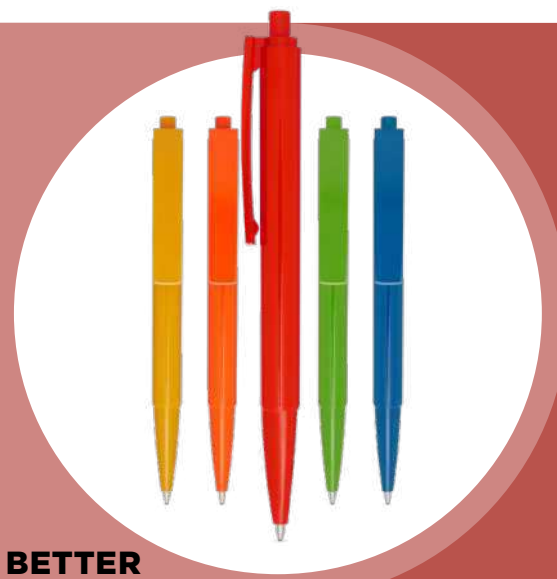

BETTER



BEST

# BALLPOINT PENS



GOOD



BETTER



BEST



# ENDLESS POSSIBILITIES ON EVERY BUDGET

No matter the budget, we make sure there's always something to match your needs. That's why our assortment is built around the idea of **Good, Better** and **Best**.

In the **Good** range, you'll discover affordable, entry-level products that are reliable and easy to use – perfect when you need practical, budget-friendly choices. Think of our **Oblys** bamboo ballpoint pen and mechanical pencil set. A simple yet stylish combination that reflects functionality and sustainability – the perfect entry point in our writing range.

Our **Better** selection offers the sweet spot between price and performance. These products give you that extra touch of quality and design, while still being great value for money. The **Didimis** recycled stainless steel pen set embodies that balance – premium materials, professional appeal, and smooth writing performance that goes a step beyond.

If you're looking for something truly premium, our **Best** range delivers exclusive products from well-known brands. These are the high-end choices that stand out, such as the **Waterman Allure** rollerball and ballpoint pen set. This set represents true craftsmanship and sophistication – a writing experience that defines excellence.

The **Good-Better-Best** structure ensures a writing solution for every price point – from budget-friendly sets to premium pens that reflect true quality and style.



#### Disclaimer

- Printing shown on products represent a variety of techniques and positions.
- Other print techniques and positions available.
- Contact us for more information.
- Images representing people and activities in this catalogue are for inspiration purposes only. Products without article codes are not for sale. The images and logos, featured on the products are for visual purposes only and may differ from the recommended print technique. Licensed products are reserved for B2B activity only and cannot under any circumstances be offered for retail sale. Only products listed with item number are available.
- Some brands are not available in all regions.
- Printing and typesetting errors reserved. The seller accepts no liability for the consequences of printing and typesetting errors.
- The certification logos (e.g. FSC®, GRS®, etc.) used in this catalogue apply solely to the certified manufacturer PF Concept International Coöperatief U.A. Any other distributor of this catalogue is not a holder of these certifications and refers to the certification holder PF Concept.  
FSC: CU-COC-877277  
GRS/RCS/OCS: CU1019665MUL-2024-00137419